

Super Fast Recovery Bridge Rectifiers

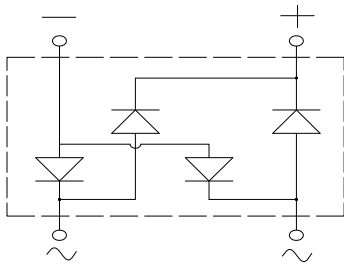
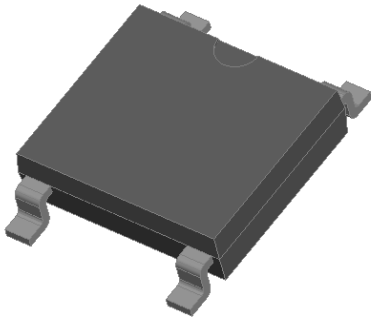

Features

- UL recognition, file #E313149
- Ideal for automated placement
- Glass passivated chip junction
- High surge current capability
- Meets MSL level 1, per J-STD-020, LF maximum peak of 260 °C

Typical Applications

General purpose use in high frequency AC/DC bridge full wave rectification for SMPS, lighting ballast, adapter, battery charger, home appliances, office equipment, and telecommunication applications.

Mechanical Data

- **Package:** ABS
Molding compound meets UL 94 V-0 flammability rating, RoHS-compliant, Halogen free
- **Terminals:** Tin plated leads, solderable per J-STD-002 and JESD22-B102
- **Polarity:** As marked on body

■ Maximum Ratings (T_a=25°C Unless otherwise specified)

PARAMETER	SYMBOL	UNIT	EABS26
Device marking code			EABS26
Maximum Repetitive Peak Reverse Voltage	VRRM	V	600
Maximum RMS Voltage	VRMS	V	420
Maximum DC blocking Voltage	VDC	V	600
Average rectified output current @60Hz sine wave, R-load, T _c =120°C	I _O	A	2.0
Forward Surge Current (Non-repetitive) @60Hz Half-sine wave, 1 cycle, T _j =25°C	I _{FSM}	A	50
Forward Surge Current (Non-repetitive) @1ms, square wave, 1 cycle, T _j =25°C			100
Current squared time @1ms≤t<8.3ms T _j =25°C, Rating of per diode	I ² t	A ² s	10.4
Storage temperature	T _{stg}	°C	-55 ~ +150
Junction temperature	T _j	°C	-55 ~ +150

■ Electrical Characteristics (T_a=25°C Unless otherwise specified)

PARAMETER	SYMBOL	UNIT	TEST CONDITIONS	EABS26
Maximum reverse recovery time	t _r	ns	I _f =0.5A, I _r =1.0A, I _r =0.25A	35
Maximum instantaneous forward voltage drop per diode	V _F	V	I _{FM} =1A	1.7
Maximum DC reverse current at rated DC blocking voltage per diode	I _R	μA	T _j =25°C	5
			T _j =125°C	100
Typical junction capacitance	C _j	pF	Measured at 1MHz and Applied Reverse Voltage of 4.0 V.D.C	21



EABS6

■ Thermal Characteristics (T_a=25°C Unless otherwise specified)

PARAMETER		SYMBOL	UNIT	EABS26
Thermal Resistance	Between junction and ambient	R θ J-A	°C/W	62.5
	Between junction and lead	R θ J-L		25.0
	Between junction and case	R θ J-C		8.0

Note: Device mounted on P.C.B with 35mm*25mm*1.7mm

■ Ordering Information (Example)

PREFERED P/N	PACKING CODE	UNIT WEIGHT(g)	MINIIMUM PACKAGE(pcs)	INNER BOX QUANTITY(pcs)	OUTER CARTON QUANTITY(pcs)	DELIVERY MODE
EABS26	F1	Approximate 0.095	4000	/	64000	13" reel
EABS26	F5	Approximate 0.095	5000	/	80000	13" reel

■ Characteristics (Typical)

FIG1: I_o-T_c Curve

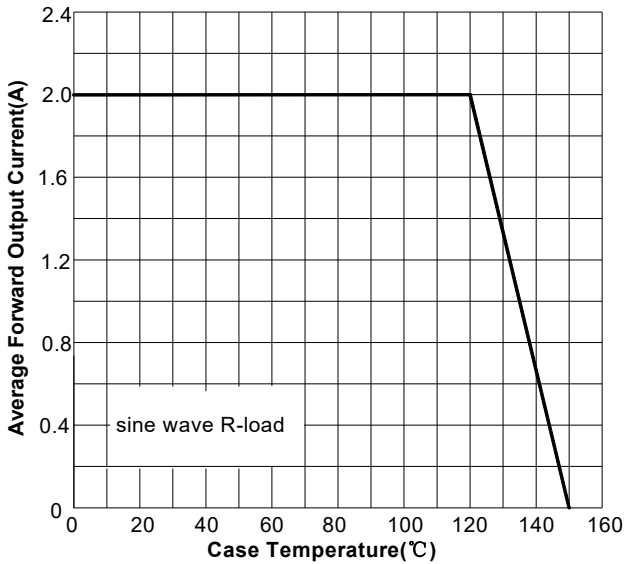

FIG2: Surge Forward Current Capability

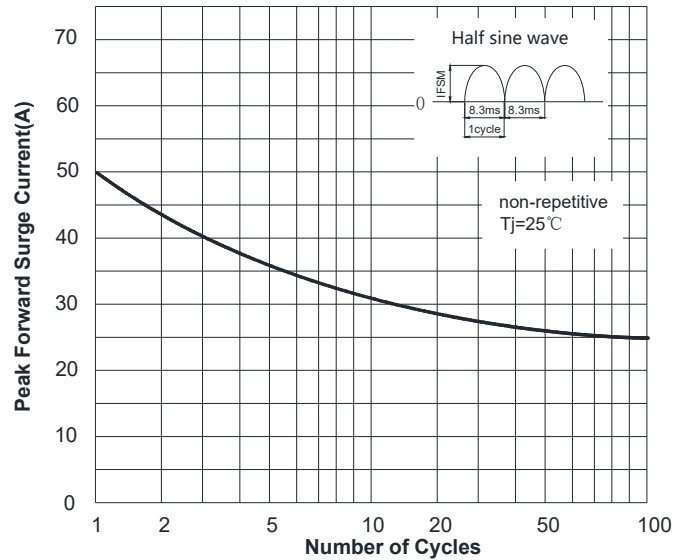

FIG3: Typical Forward Voltage

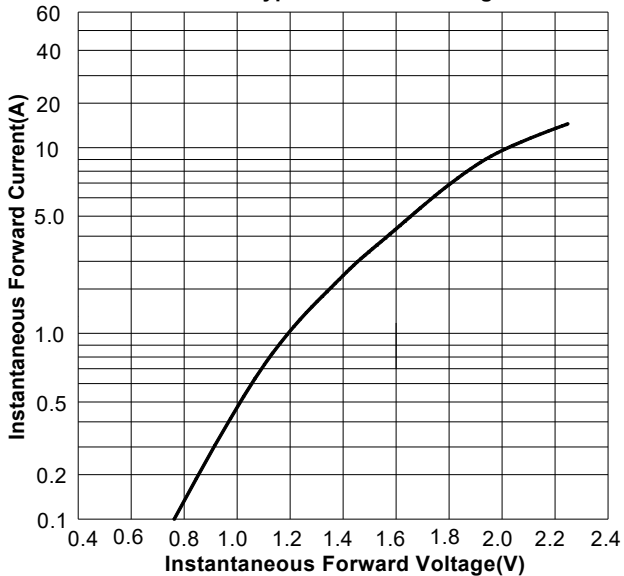

FIG4: Typical Reverse Characteristics

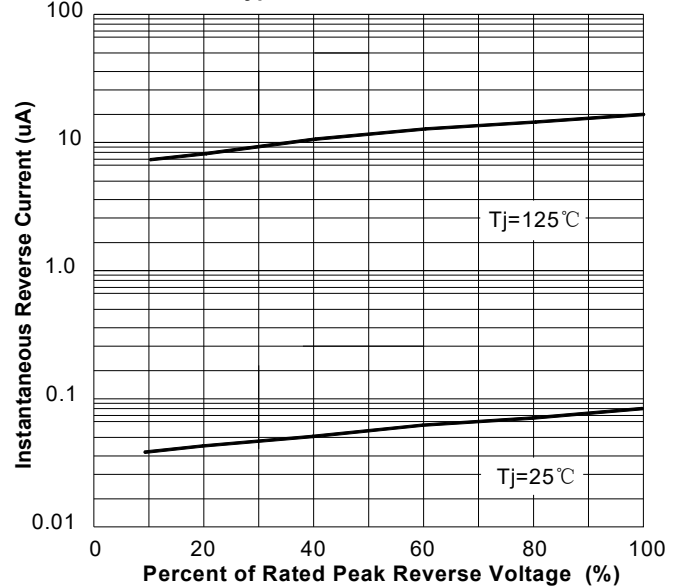
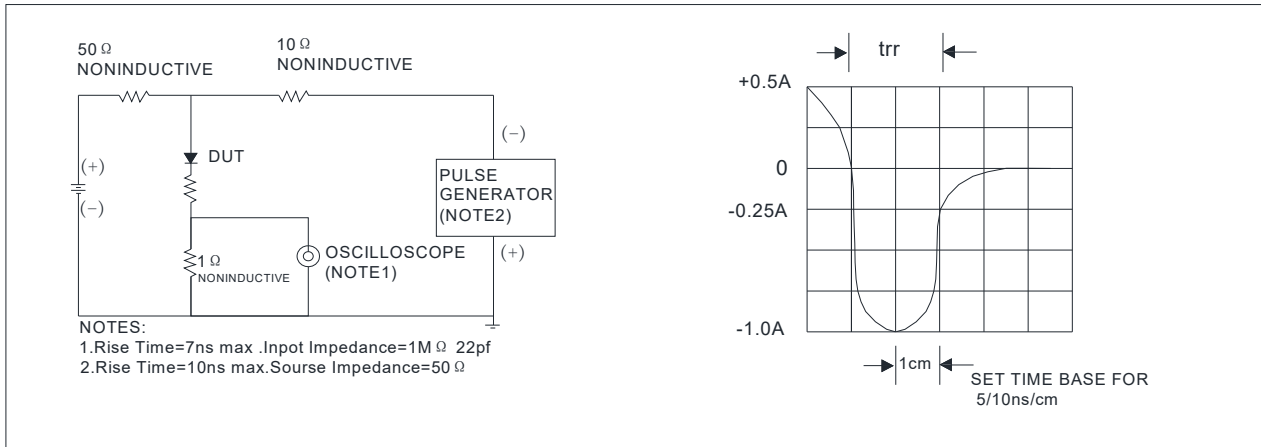
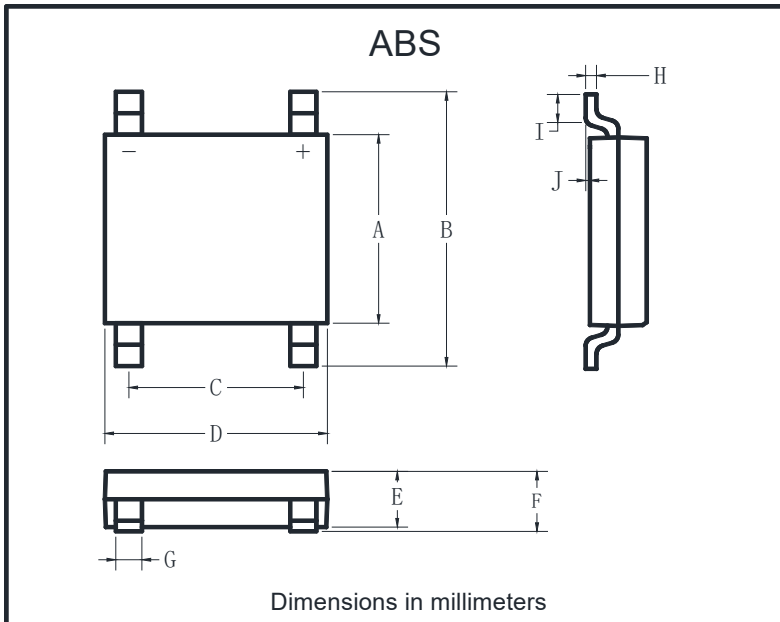

FIG.5: Diagram of circuit and Testing wave form of reverse recovery time



■ Outline Dimensions



ABS		
Dim	Min	Max
A	4.30	4.50
B	6.00	6.40
C	3.90	4.10
D	4.90	5.10
E	1.25	1.45
F	1.60 Max	
G	0.60	0.70
H	0.15	0.25
I	0.30	0.80
J	0.02	0.15

■ Suggested pad layout

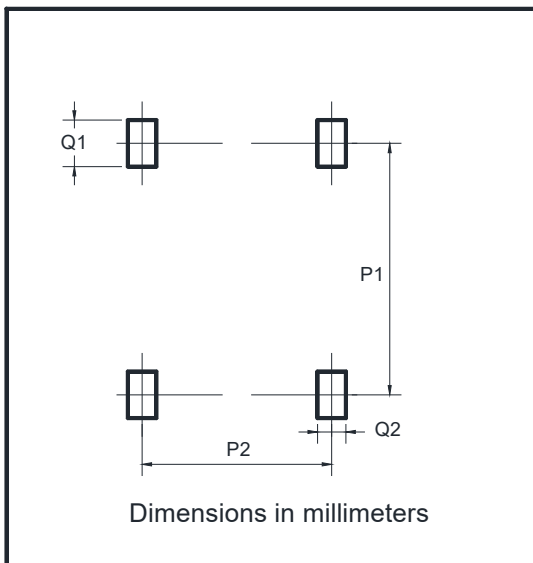

Dim	Min
P1	5.72
P2	4.00
Q1	1.00
Q2	0.90



EABS6

Disclaimer

The information presented in this document is for reference only. Yangzhou Yangjie Electronic Technology Co., Ltd. reserves the right to make changes without notice for the specification of the products displayed herein to improve reliability, function or design or otherwise.

The product listed herein is designed to be used with ordinary electronic equipment or devices, and not designed to be used with equipment or devices which require high level of reliability and the malfunction of which would directly endanger human life (such as medical instruments, transportation equipment, aerospace machinery, nuclear-reactor controllers, fuel controllers and other safety devices), Yangjie or anyone on its behalf, assumes no responsibility or liability for any damages resulting from such improper use of sale.

This publication supersedes & replaces all information previously supplied. For additional information, please visit our website [http:// www.21yangjie.com](http://www.21yangjie.com) , or consult your nearest Yangjie's sales office for further assistance.